

---

montagehandleiding  
conseils de montage  
Montageanleitung  
assembly instructions



---

LUTRA BOX<sup>®</sup> 240R

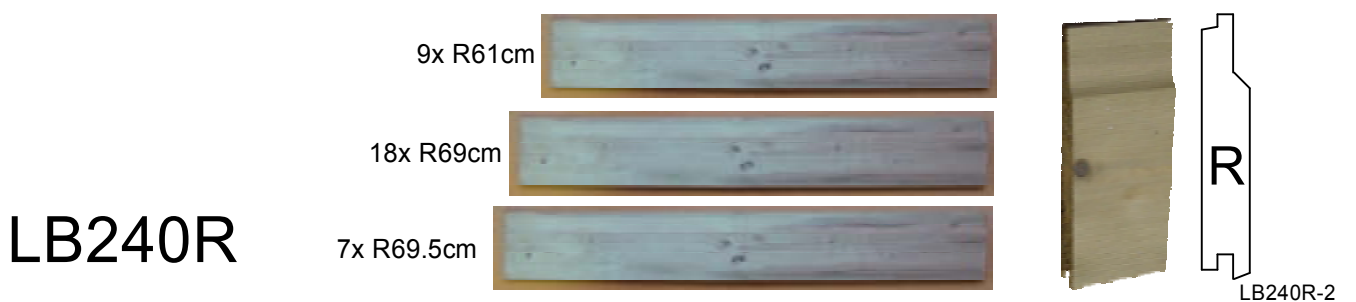
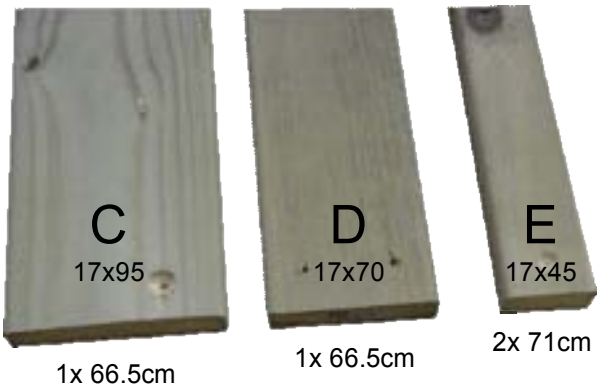
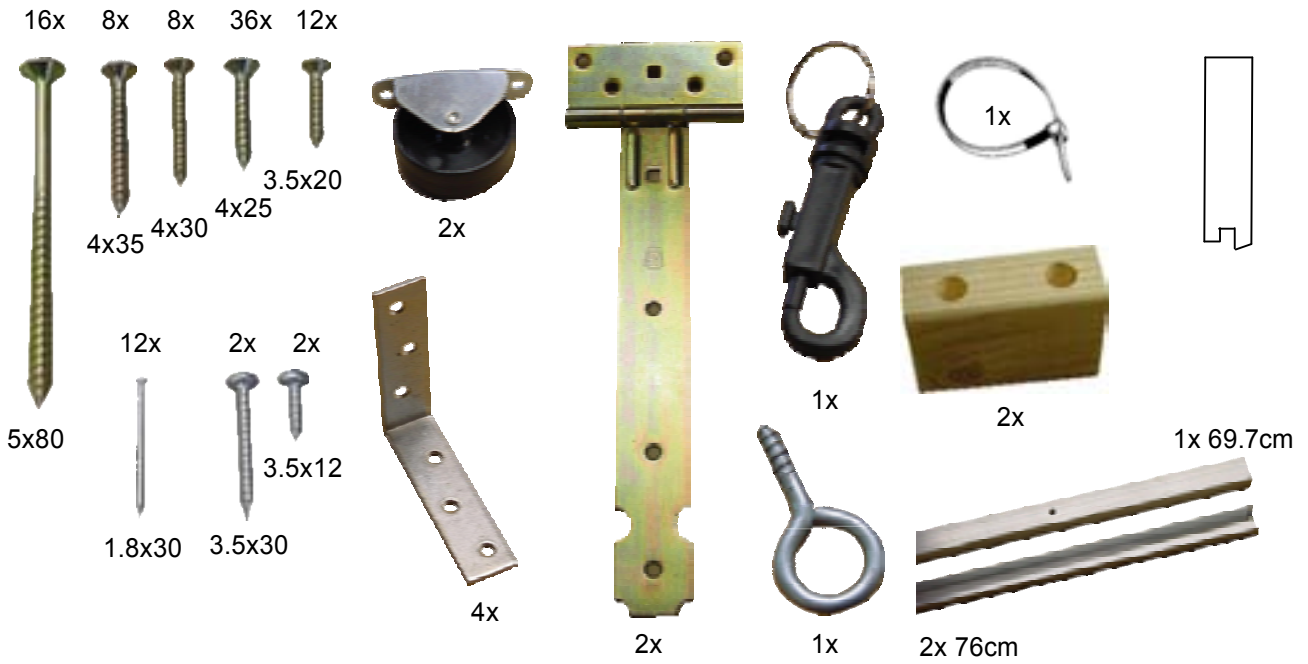

---

NL

### Montage

Neem deze instructie in de juiste volgorde aandachtig en volledig door voordat u aan de montage begint.

Sorteer de verschillende onderdelen en vergelijk ze met de onderdelenlijst. Controleer of u over alle onderdelen beschikt.

Om splinters te vermijden kunt u de hoeken, randen en puntige delen van het hout schuren. Onder invloed van temperatuurwisselingen en vochtinwerking zal hout uitzetten en krimpen waardoor kleine haarscheurtjes ontstaan. Dit is een natuurlijk verschijnsel en heeft geen consequenties voor de sterkte en de levensduur van uw LUTRA BOX®. De rabatdelen krimpen bij grote droogte; dit wordt automatisch hersteld bij een hogere luchtvochtigheid. De delen zetten dan namelijk weer uit.

*Ofschoon het hout geïmpregneerd is en geen behandeling nodig heeft, kan een regelmatige behandeling met een buitenbeits eventuele scheurvorming tegengaan. Het voorkomt zowel houtrot door de inwerking van vocht als de verkleuring van het hout.*

### Gebruik

Voor een goede werking is het noodzakelijk dat de LUTRA BOX® op een harde, en vlakke ondergrond staat en niet in directe wind. Na montage rijdt u de LUTRA BOX® over de afvalcontainer heen en verbind het kabelbandje met het deksel aan de leidselveer! Als de afvalcontainer aan de straat gezet moet worden, maakt u het kabelbandje weer los en rijdt de LUTRA BOX® van de afvalcontainer af.

### Veiligheid

Houd het deksel van de LUTRA BOX® bij openen en sluiten altijd vast om te voorkomen dat het automatisch dichtvalt. Pas op dat lichaamsdelen hierdoor niet bekneld raken.

**Benodigd gereedschap:** Duimstok- Kruiskopschroevendraaier (of schroefmachine bitmaat Posidrive nr. 2) – Winkelhaak Boormachine – Schuurpapier – Hamer - Zaag

F

### Conseils de montage

Étudiez ces instructions complètement et entièrement avant de commencer le montage. Rangez les différentes parties du kit et comparez-les avec la liste des parties. Vérifiez si vous avez chaque partie. Pour éviter des échardes, récurvez les bouts, les artes et toutes les saillies de bois avec du papier de verre.

### L'entretien

Le bois se contracte et s'étend sous l'influence du temps et l'humidité. Ceci peut provoquer de petites déchirures. C'est un phénomène tout à fait naturel qui n'as pas de conséquences pour la solidité ou la durabilité de votre LUTRA BOX®. *Le bois est imprégné à la haute pression, et fonctionne sans entretien. Un traitement régulier avec du vernis prévient l'éventuelle déchirage et prévient aussi la pourriture et la décolorisation du bois.*

### Placement

Il faut installer le LUTRA BOX® sur une surface plane et dure: le béton, la terre battue ou l'asphalte.

### Sécurité et responsabilité

Si vous ne tenez pas le couvercle du LUTRA BOX® il va tomber automatiquement. Attention que parties du corps ne sont pas serrés.

**Outils requis:** Mètre à ruban – Crayon – Perceuse avec Posidrive nr. 2 bit – Equerre – Marteau - Scie à main

D

### Montageanleitung

Lesen Sie zuerst diese Montageanleitung aufmerksam durch. Legen Sie alle Teile zurecht und vergleichen Sie diese mit der Inhaltsliste. Kontrollieren Sie ob alle Teile vorhanden sind. Die Ecken, Kanten und alle Holzspitzen zur Vermeidung von Splintern schmirgeln.

### Pflege

Holz arbeitet unter dem Einfluß von Temperatur und Schwankungen der Luftfeuchtigkeit. Dadurch entstehen Risse und das Holz splittert. Das ist ein natürlicher Vorgang und beeinträchtigt die Lebensdauer und Stärke des Materials in keiner Weise. *Obwohl das Holz imprägniert ist, und keine Pflege braucht, kann die LUTRA BOX® durch regelmäßiges Beizen vor Verwitterung geschützt werden.*

### Platzierung

Für eine gute Wirkung ist es notwendig die LUTRA BOX® auf Beton, Asphalt oder ähnlichen harten Flächen auf zu stellen.

### Sicherheit und Haftung

Wenn Sie den Deckel der LUTRA BOX® nicht festhalten wird er automatisch herunterfallen. Achten Sie darauf daß keine Körperteile eingeklemmt werden.

**Erforderliche Werkzeuge:** Maßband- Bleistift - Bohrmaschine mit Posidrive nr. 2 - Winkel - Hammer - Handsäge

GB

### Assembly instructions

Carefully read these assembly instructions before you start. Check all the parts and group them systematically within reach. Compare these with the parts list. To prevent splinters, smooth the corners, edges and all the points of the wood with a piece of sandpaper.

### Maintenance

Wood will expand and contract as it adjusts to changes in temperature and humidity. This results in checks or cracks and is a natural characteristic of all wood. It will not affect the strength or durability of your LUTRA BOX®. *The wood is high pressure treated, and needs no maintenance. However maintaining the LUTRA BOX® with periodic applications of exterior stain will greatly minimise the weathering of the wooden surfaces.*

### Installation

It is necessary to install the LUTRA BOX® on a flat, hard surface like concrete, asphalt etc.

### Safety and liability

When you do not hold the cover of the LUTRA BOX® it will automatically fall down. Be aware that no parts of the body are oppressed.

**Required tools:** Tape measure - Pencil - Electric drill with Posidrive nr. 2 bit - Combination square - Hammer - Hack saw

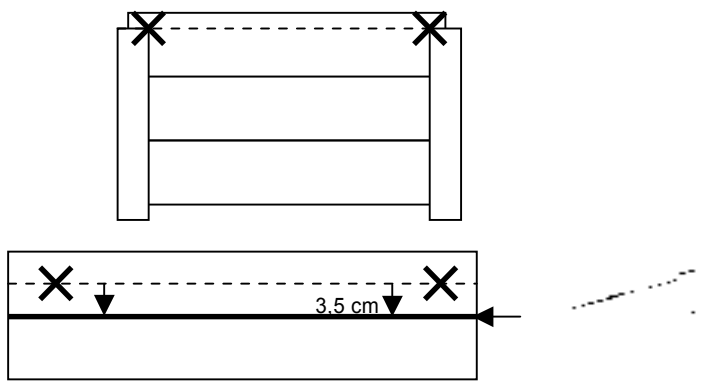
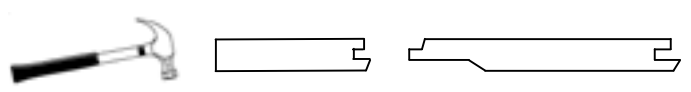
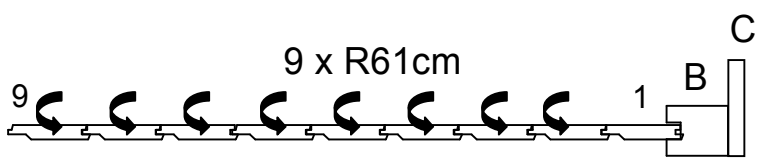
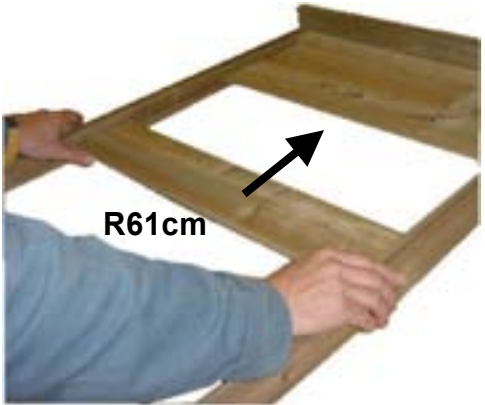
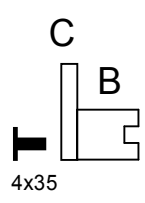
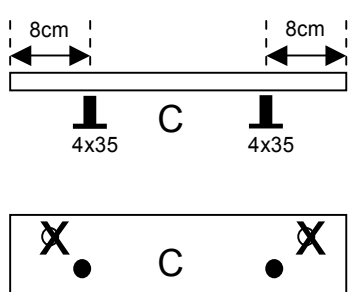
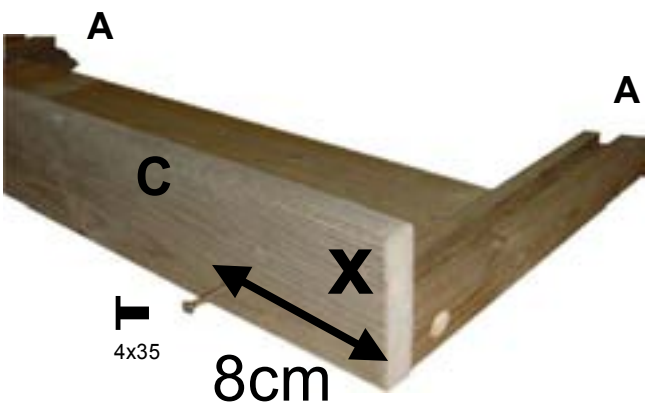
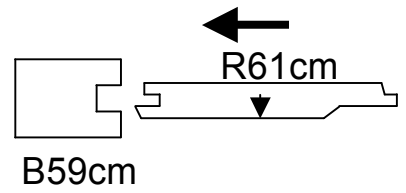
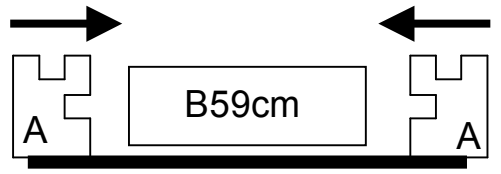
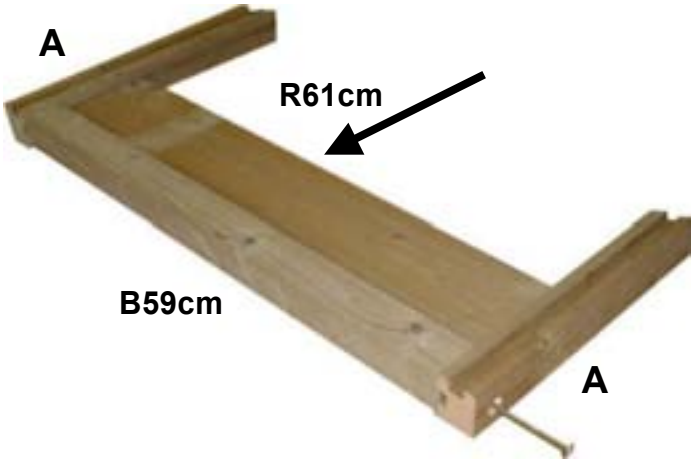

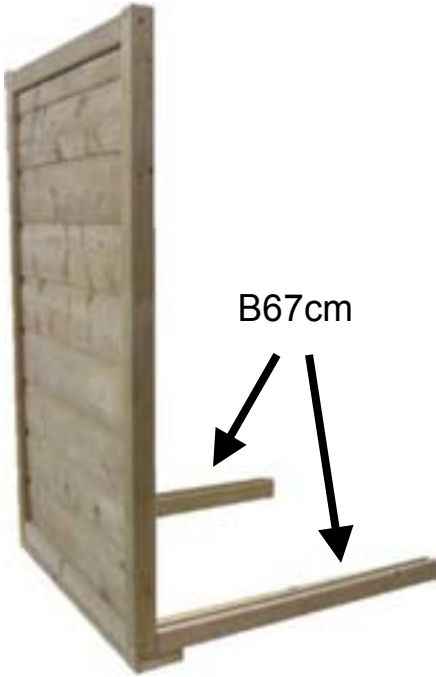
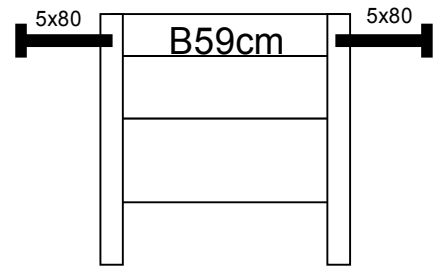
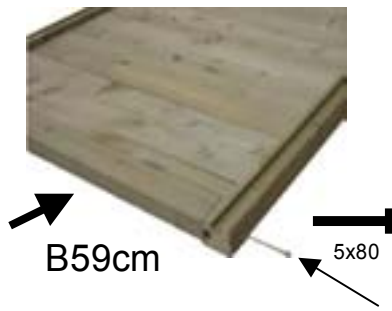

C

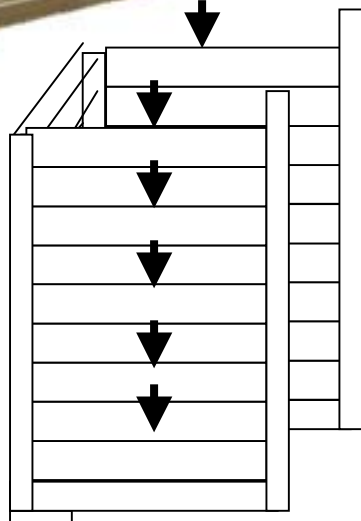
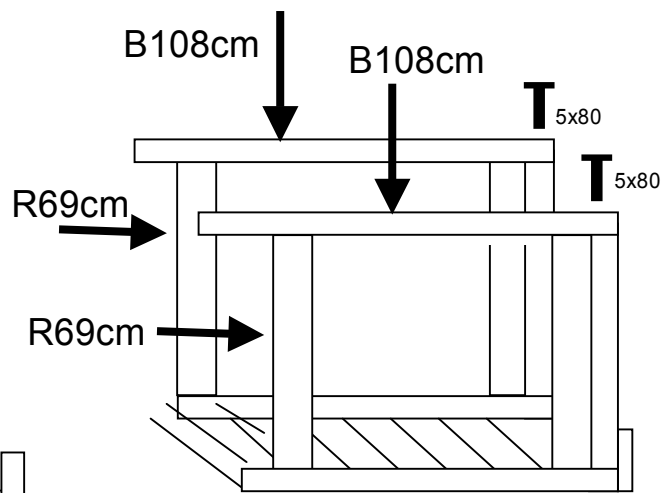
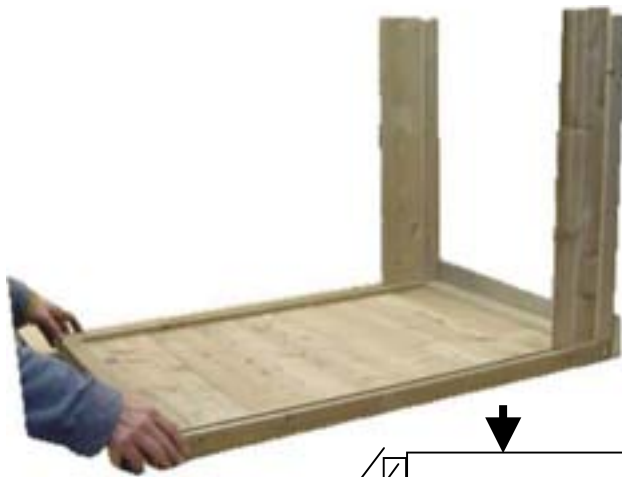
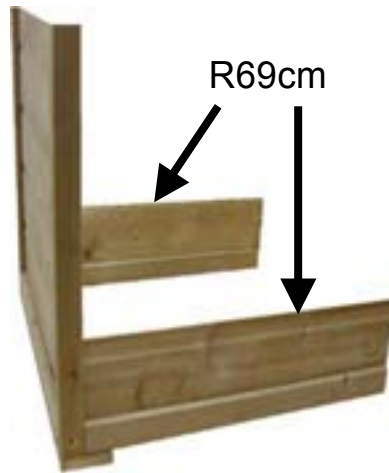

2 x 9 R69cm

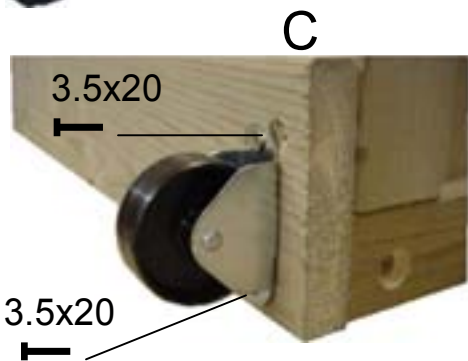
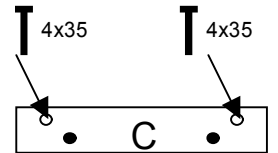
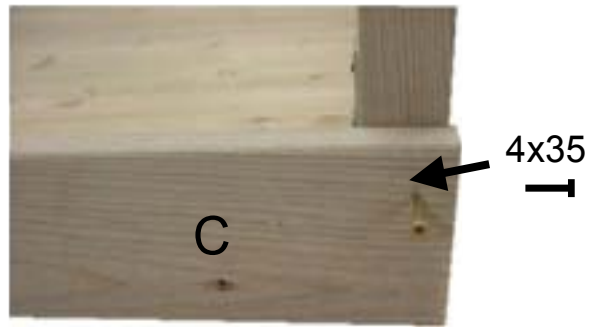
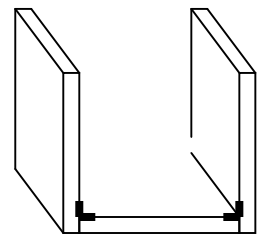
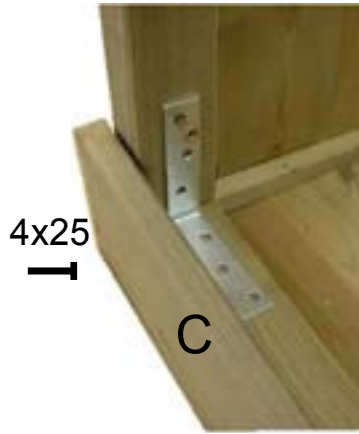
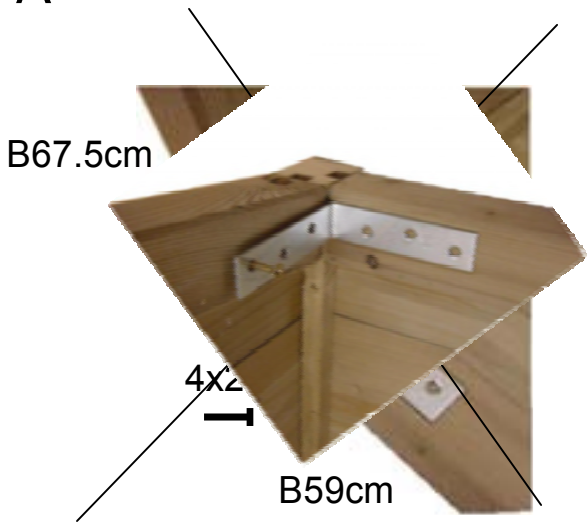
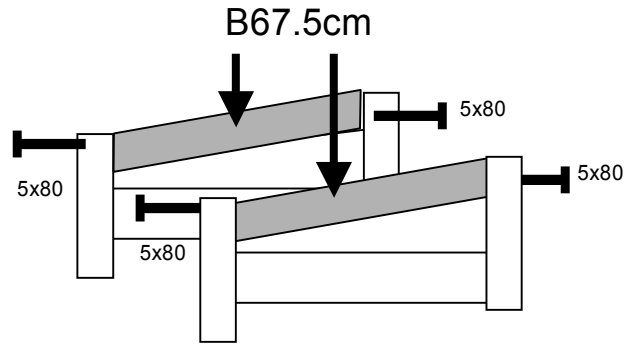
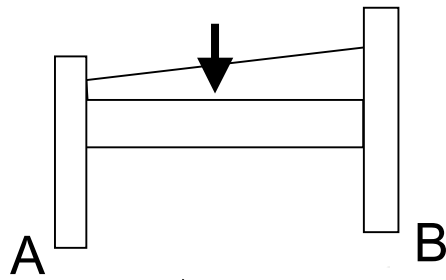
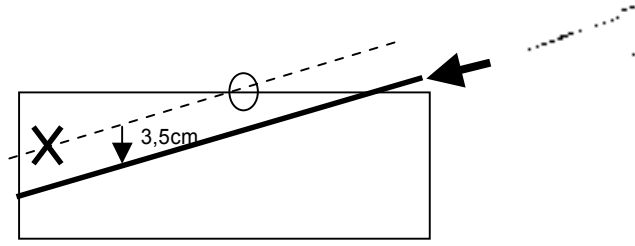
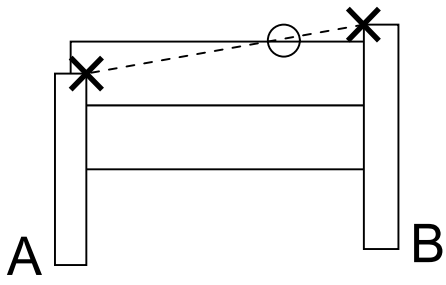

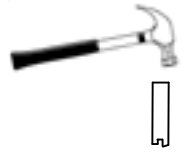
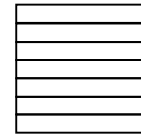

7 x R69.5cm

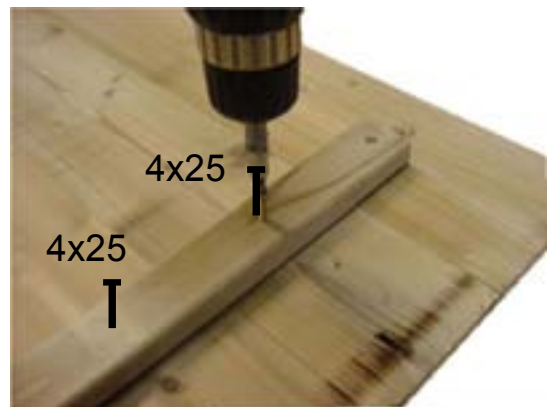
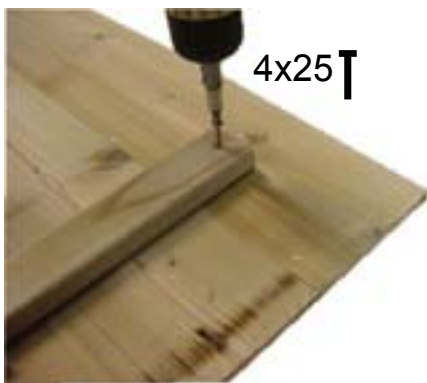
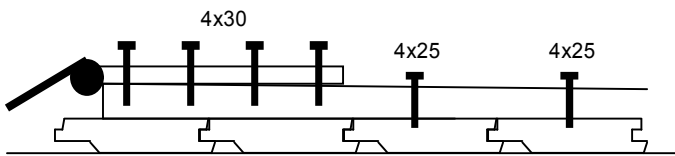
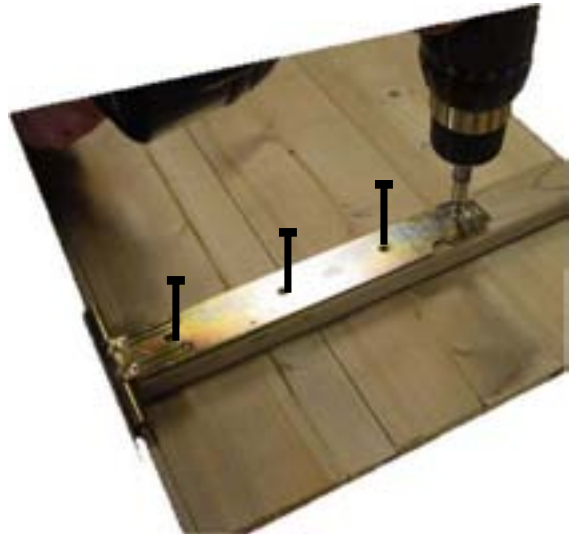
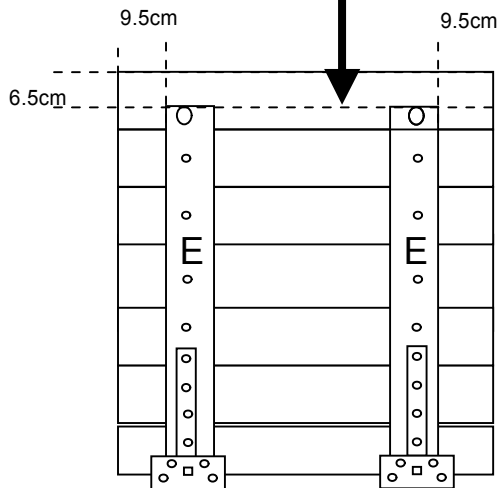
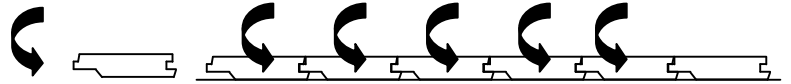

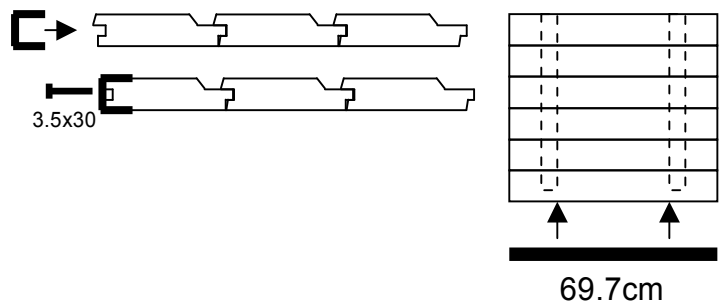
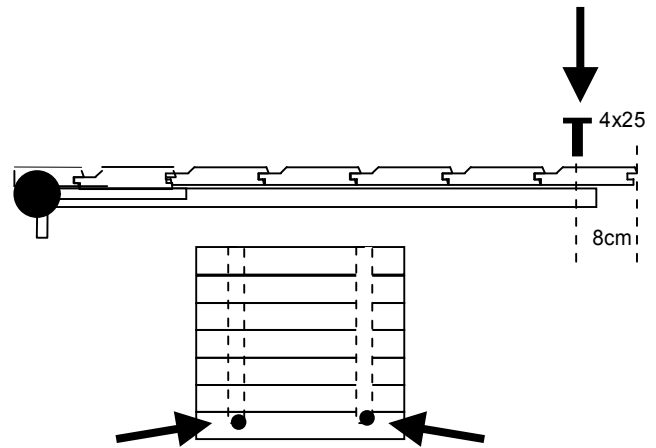
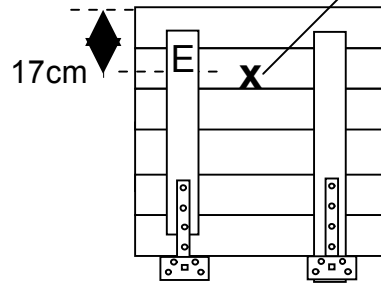
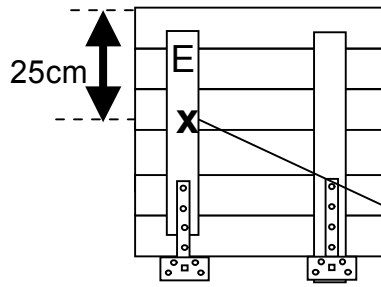

↑  
3.5x12

